



We create with passion



1st manufacturer of firefighting equipment in France

ENGLISH

CATALOGUE NAVY



POK SAS - ZI les Guignons - 10400 Nogent-sur-Seine - FRANCE

Tel : +33 (0)3 25 39 84 78 - Fax : +33 (0)3 25 39 84 90 - Email : info@pok.fr - web : www.pok.fr

RCS : Troyes 90 B 279

Photographs, pictures and texts are not contractually binding.
The information presented in this catalogue is subject to change without notice.

POK SAS is certified

ISO 9001:2008
and
ISO 14001:2009 + Cor 1:2009



CERTIFICATE

This is to certify that

POK SAS
ZONE INDUSTRIELLE DES GUIGNONS
10400 NOGENT SUR SEINE
FRANCE

with the organizational units/sites as listed in the annex
has implemented and maintains a **Quality Management System**.

Scope:
Manufacturing and after sales services of fire fighting equipments

Through an audit, documented in a report, it was verified that the management system fulfills the requirements of the following standard:

ISO 9001 : 2008

Certificate registration no. 499620 QM08
Valid from 2013-12-22
Valid until 2016-12-21
Date of certification 2013-12-22

DQKs
Deutsche
Akkreditierungsstelle
D-ZM-162/14-01-03

DQS GmbH
G. Bleichschmidt
Götz Bleichschmidt
Managing Director

Accredited Body: DQS GmbH, August-Schanz-Straße 21, 60433 Frankfurt am Main

1 / 2

CERTIFICATE

This is to certify that

POK SAS
ZONE INDUSTRIELLE DES GUIGNONS
10400 NOGENT SUR SEINE
FRANCE

with the organizational units/sites as listed in the annex
has implemented and maintains an **Environmental Management System**.

Scope:
Manufacturing and services of fire fighting equipments

Through an audit, documented in a report, it was verified that the management system fulfills the requirements of the following standard:

ISO 14001 : 2004 + Cor 1 : 2009

Certificate registration no. 499620 UM
Valid from 2013-12-22
Valid until 2016-12-21
Date of certification 2013-12-22

DQKs
Deutsche
Akkreditierungsstelle
D-ZM-162/14-01-03

DQS GmbH
G. Bleichschmidt
Götz Bleichschmidt
Managing Director

Accredited Body: DQS GmbH, August-Schanz-Straße 21, 60433 Frankfurt am Main

1 / 2



Hand nozzles
Page 6

Monitors
Page 12

Outlet equipment
Page 18

Foam equipment
Page 22

Dividers
Page 28

Mobile-eductors, strainers
Page 29

Hose reels, foam stations
Page 30

Couplings, caps
Page 32

Spanner wrenches
Page 35

Annex
Page 36

LEGENDE 500 for electric fires

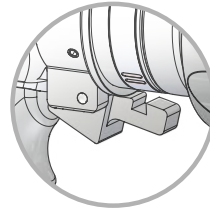

Trigger lock for the straight jet and FLUSH positions.

Maximum working pressure: PN16
Shutoff: with slide valve
Opening: by operating handle
Flush position: YES
Straight jet locking: YES
Material: aluminium alloy
Surface treatment: hard anodisation
Body type: cut into bars
Head: moulded teeth
Pistol grip: one

Options: low expansion foam attachment, medium expansion foam attachment.

Bumper guard colour:

The range of "Legende DHT" nozzles with automatic regulated pressure is used for the extinction of electric fires.

The head ring with tactile markings allows to select different stream patterns (straight jet, flash over and wide angle spray). The shutoff handle enables to change to different flow rates. A locking device helps to prevent going to straight jet accidentally allowing a safe use on electric fires.

Inlet	Flow rate	Working pressure	Dimensions (mm)	Weight (kg)	Ref.
1.5" NST-NH female	400 lpm	7 bar	302 x 228 x 97	2,1	25581

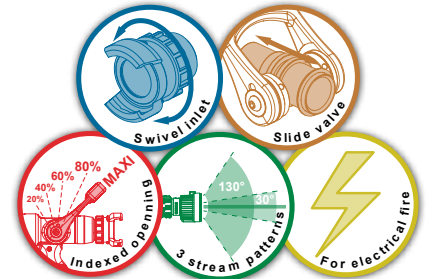

LEGENDE 500 with combined stream patterns



Maximum working pressure: PN16
Shutoff: with slide valve
Opening: by operating handle
Flush position: YES
Material: aluminium alloy
Surface treatment: hard anodisation
Body type: cut into bars
Head: moulded teeth
Pistol grip: one

Options: low expansion foam attachment.

Bumper guard colour:

The "Legende" range of nozzles with automatic regulated pressure and combined stream patterns helps to obtain simultaneous a straight jet and wide angle spray to protect the fireman.

The shutoff handle allows to select different flow rates.

Inlet	Flow rate	Working pressure	Dimensions (mm)	Weight (kg)	Ref.
M56 x 400 female (Uni 811)	475 lpm	7 bar	328 x 228 x 84	1,98	19368

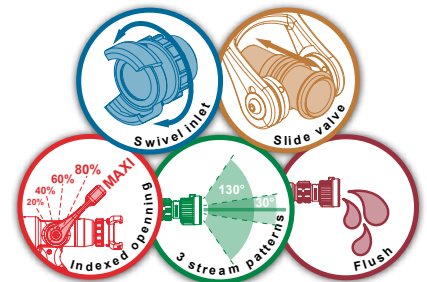

Hand nozzles - Fixed flow rate



The Pokabronze nozzle with fixed flow rate is entirely made of bronze. It comes with a moulded teeth tip.

The bumper guard allows the selection of different stream patterns (straight jet, flashover and wide angle spray).

The US Navy chose these nozzles to protect its ships against fire.

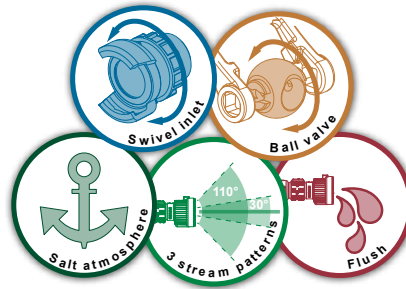

Maximum working pressure: PN16

Shutoff: with ball valve

Opening: by operating handle

Flush position: YES

Material: bronze

Body type: moulded

Head: moulded teeth

Pistol grip: one

Options: low expansion foam attachment, medium expansion foam attachment.

Bumper guard colour: ●

POKABRONZE 500



Inlet	Flow rate	Working pressure	Dimensions (mm)	Weight (kg)	Ref.
1.5" NST-NH female	60 gpm	100 psi	220 x 237 x 116	3,93	08986
1.5" NST-NH female	125 gpm	100 psi	220 x 237 x 116	3,93	08988
1.5" NPSH female	95 gpm	100 psi	220 x 237 x 116	3,93	14497
DSP DN40	500 lpm	6 bar	220 x 237 x 116	3,93	16184

POKABRONZE 1000



Inlet	Flow rate	Working pressure	Dimensions (mm)	Weight (kg)	Ref.
2" BSP male	1000 lpm	6 bar	273 x 243 x 120	5,67	16187
2.5" NST-NH female	250 gpm	100 psi	273 x 243 x 120	5,67	17090

The entire range of Turbokador nozzles are in stainless steel with selectable flow rate are available with several tips: aluminium or bronze, for electric fires. The stream pattern is obtained by rotating the head ring. The selection of the flow rates is done by rotating the ring. These nozzles are marine and made to last in a corrosive environment.

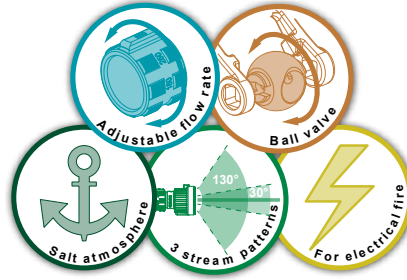

Maximum working pressure: PN16
Shutoff: with ball valve
Opening: by operating handle
Flush position: YES
Material: bronze, stainless steel, aluminium
Body type: moulded
Head: spinning teeth
Pistol grip: one
Options: low expansion foam attachment, medium expansion foam attachment.
Bumper guard colour: ●

TURBOKADOR 500 for electric fires - marine type

Body in stainless steel 316L, tip in bronze



Inlet	Flow rate	Working pressure	Dimensions (mm)	Weight (kg)	Ref.
SG DN40	200-300-500 lpm	6 bar	266 x 248 x 93	4,92	00235

TURBOKADOR 500 for electric fires - marine type

Body in stainless steel 316L, tip in anodised aluminium alloy



Inlet	Flow rate	Working pressure	Dimensions (mm)	Weight (kg)	Ref.
SG DN40	200-300-500 lpm	6 bar	266 x 248 x 93	4,92	08049

The fog application nozzle is used to clean large tanks.

A fog head is screwed to the end of the nozzle to ensure a homogeneous spray. Depending on the shape of the tank, several configurations are possible: elbow of 45° or 90°.

It can also be equipped with a filter shutoff for opening and closing the waterway.

Maximum working pressure: PN16

Valve type: ball valve

Operation: by manoeuvre handle

Material: stainless steel

Bumper guard colour:



FOG APPLICATION NOZZLE - Filter shutoff



Inlet	Outlet	Flow rate	Working pressure	Dimensions (mm)	Weight (kg)	Ref.
SG DN40	SG DN40	460 lpm	7 bar	407 x 127 x 163	2,35	07353

FOG APPLICATION NOZZLE - straight extension-piece



Inlet	Outlet	Dimensions (mm)	Weight (kg)	Ref.
SG DN40	SG DN40	1600 x 75 x 75	1,28	07357

FOG APPLICATION NOZZLE - applicator with 90° bend



Inlet	Outlet	Dimensions (mm)	Weight (kg)	Ref.
SG DN40	1" BSP male	1673 x 75 x 406	1,40	07354

FOG APPLICATION NOZZLE - applicator with 45° bend



Inlet	Outlet	Dimensions (mm)	Weight (kg)	Ref.
SG DN40	1" BSP male	1778 x 75 x 306	1,33	07356

FOG APPLICATION NOZZLE - fog head



Inlet	Flow rate	Working pressure	Dimensions (mm)	Weight (kg)	Ref.
1" BSP female	460 lpm	7 bar	152 x 42 x 42	1,28	07355

Petrol industry nozzle



Working pressure: PN16
Opening: by rotation of head ring
Material: bronze
Body type: moulded



Inlet	Flow rate (lpm)	Working pressure (bar)	Dimensions (mm)	Weight (kg)	Ref.
Instantaneous 2.5" male	450	6	167 x 93 x 93 x	2,70	20049

Bronze branchpipes



The range of branchpipes are available in aluminium or in bronze for diameters from 20 to 65. Composed of one inlet coupling and thread outlet. They are designed to be assembled with conical smooth bore tips or nozzle shutoffs. They are also available for coupling with locking ring in compliance with norme NF E 29.572.

Working pressure: PN16
Material: bronze

Inlet	Diameter (mm)	Standard	Dimensions (mm)	Weight (kg)	Ref.
SG DN20	20/10	NF E 29-572	142 x 46 x 31	0,31	02198
GFR DN20	20/10	NF E 29-579	157 x 52 x 52	0,45	02200
Hose shank Ø25	20/10			0,29	01890
SG DN40	40/20	NF E 29-572	177 x 64 x 54 x	0,68	02197
Hose shank Ø35	40/20		180 x 43 x 43 x	0,51	01879
SG DN65	65/40	NF E 29-572	325 x 104 x 83 x	1,86	02432



Deluge nozzles DMA with spray pattern



The DMA nozzle shutoff has three positions: closed, wide spray angle, straight jet. It is designed to connect with branchpipes offering a light and efficient nozzle with a good compromise.

Working pressure: PN16
Shutoff: with ball valve
Stream pattern: closed, spray and straight stream
Opening: by operating handle
Material: aluminium alloy or brass
Body type: moulded

Options: branchpipe, red or yellow shutoff handle

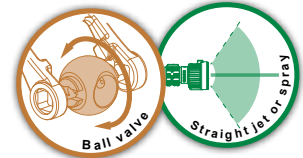

Inlet	Diameter (mm)	Dimensions (mm)	Aluminium		Bronze	
			Weight (kg)	Ref	Weight (kg)	Ref
ISO M24 x 200 female	25/8-8				0,98	32899
ISO M36 x 200 female	40/12-12		0,85	07330		
ISO M36 x 200 female	40/14-14				1,59	07683
ISO M52 x 300 female	65/18-15		0,88	07331		

Deluge nozzles DMB



The DMB nozzle shutoff has three positions: closed, flat stream, straight jet. It is designed to be connected with branchpipes to allow several possibilities depending on circumstances.

Working pressure: PN16
Shutoff: with ball valve
Stream pattern: closed and spray
Opening: by operating handle
Material: aluminium alloy or brass
Body type: moulded

Options: branchpipe, red or yellow shutoff handle



Inlet	Diameter (mm)	Dimensions (mm)	Aluminium		Bronze	
			Weight (kg)	Ref	Weight (kg)	Ref
ISO M24 x 200 female	20/7-7		0,39	07350		07360
ISO M36 x 200 female	40/12-12		0,46	02784	0,89	02837
ISO M36 x 200 female	40/14-14					07361
ISO M52 x 300 female	65/18-15				1,48	07362
ISO M52 x 300 female	65/18-18			09285		



DN65 fixed monitor with handwheels, in bronze



Recommended outlet equipment
Ø 2.5"
 Flow rate
2000 lpm

Maximum working pressure: PN16
Material: bronze
Horizontal movement: on 360°
Horizontal adjustment: by handwheel
Vertical movement: from -50° to +90°
Vertical adjustment : by handwheel
Options: outlet equipment, flange

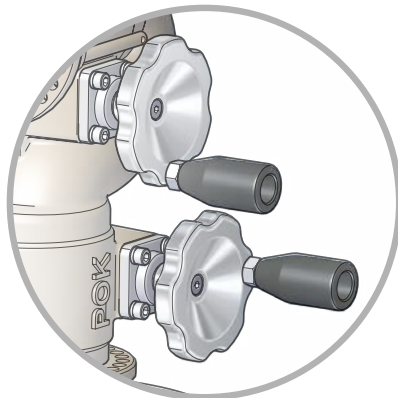

Handwheel for vertical position and horizontal position

Salt atmosphere
 Vertical range
 Horizontal range

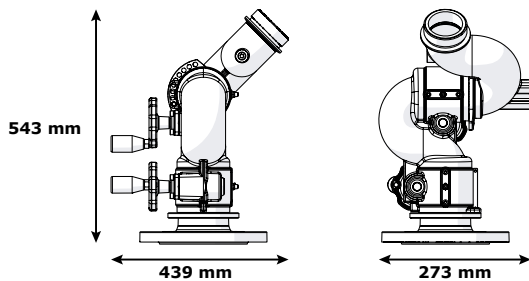

Our fixed monitor nozzle DN65 in bronze is made to be used in a marine environment and is PN16.

The flow rate can go up to 2,000 lpm at 7 bar at the monitor's outlet. Elevation range is from -50° to +90°, horizontal range 360° by handwheels. It can be equipped with different outlet equipment or couplings.

Inlets	Outlet	Waterway Ø (mm)	Folded dimensions (mm)	Weight (kg)	Ref
Flange 4" ASA150	2.5" NST-NH male	65		22,20	20432

DN80 fixed monitor with handwheels, in bronze



Recommended outlet equipment
 Ø 3''
 Flow rate 5000 lpm

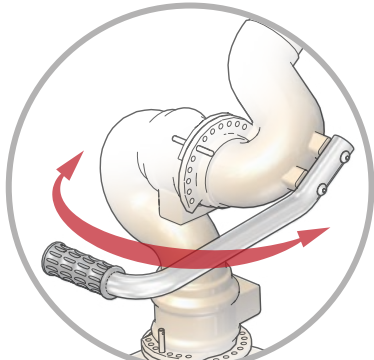

Handle with locking pin for vertical and horizontal position

Maximum working pressure: PN16
Material: bronze
Body type : moulded
Horizontal movement: on 360°
Horizontal adjustment: by handwheels, by handle or by chains
Vertical movement: from -60° to +85°
Vertical adjustment : by handwheels, by handle or by chains
Options: outlet equipment, flange

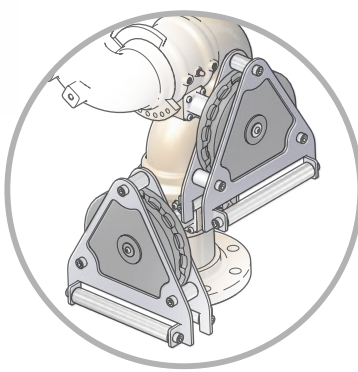

Wheels with markprint for remote control by chain

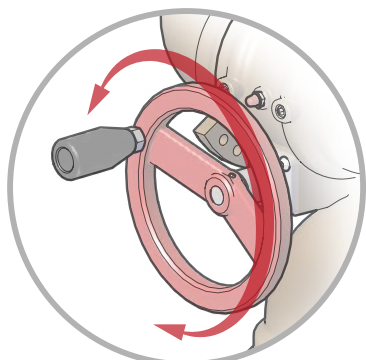

Operating handwheels for vertical and horizontal positions

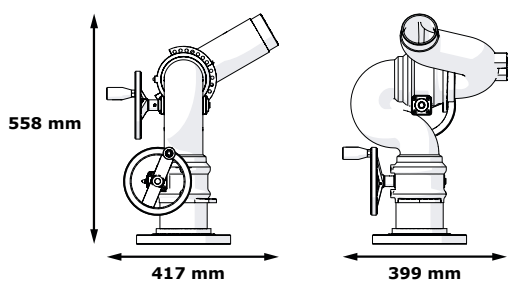

The DN80 monitor in bronze is made to be used in a marine environment. The set up of the elevation position from -60° to +85° and in horizontal 360° can be done thanks to operating handwheels, handle or chains. It can be equipped with different outlet equipment or couplings.

Inlet	Outlet	Waterway Ø (mm)	Operating device	Dimensions (mm)	Weight (kg)	Ref
Flange 4" ASA150	3" BSP male	80	by handwheels	417 x 399 x 558	36,15	34377
Flange 4" ASA150	3" BSP male	80	by handle	573 x 419 x 566	41,28	34457
Flange 4" ASA150	3" BSP male	80	by chains	444 x 380 x 558	57,94	34343

Mercator - DN80 fixed monitor, in stainless steel



Recommended outlet equipment
 Ø 2.5"
 Flow rate 3000 lpm

Maximum working pressure: PN16
Material: stainless steel
Horizontal movement: on 360°
Horizontal adjustment: by handle
Vertical movement: from -60° to +80°
Vertical adjustment: by handle
Options: outlet equipment

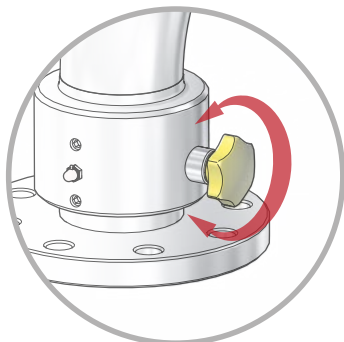

Locking knob for vertical and horizontal position

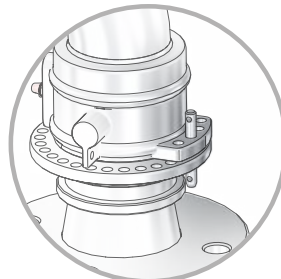

Optional: replacement for the locking knob by a pin

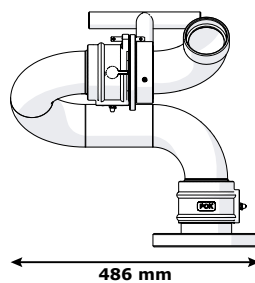
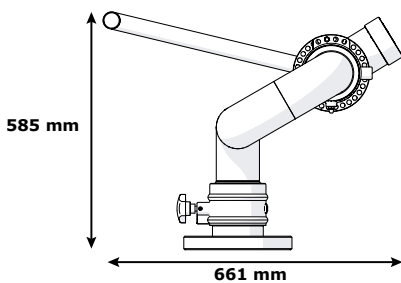

Our fixed monitor "Mercator 3000" is made of stainless steel, PN16 designed. Flow rate can go up to 3,000 lpm at 7 bar at the monitor's outlet. Horizontal range is 360° by handle with locking. Elevation range is -60° to +80° by setting tray with locking knob. It can be equipped with different outlet equipment or inlet flanges.

Inlets	Outlet	Waterway Ø (mm)	Folded dimensions (mm)	Weight (kg)	Ref
Flange DN80 PN16	2.5" BSP female	80	661 x 486 x 585	17	03487

DN65 portable monitor, in stainless steel



Recommended outlet equipment
 ø 2.5"
 Flow rate 3000 lpm

Maximum working pressure: PN16
Material: stainless steel
Horizontal movement: on 360°
Horizontal adjustment: by handle
Vertical movement: from -50° to +90°
Vertical adjustment : by handwheel
Safety: locking knob for horizontal adjustment

Options: outlet equipment, coupling

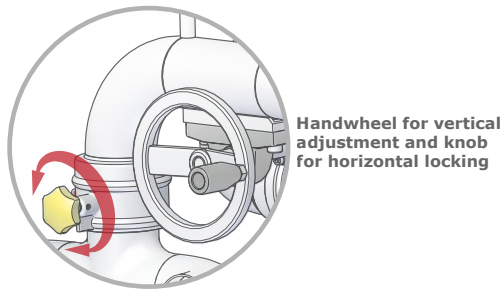

Salt atmosphere
Vertical range
Horizontal range
Adjustable on trailer

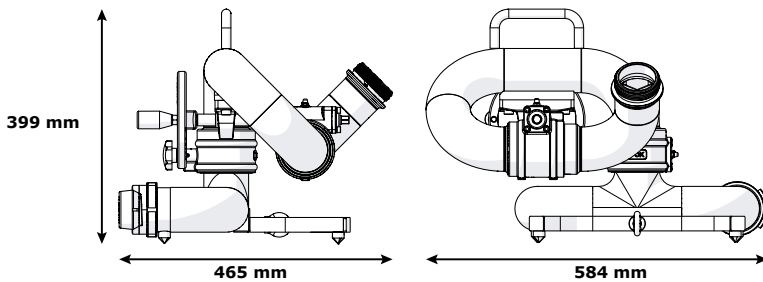

Our portable monitor DN650 is made of stainless steel, PN16 design. Flow rate can go up 3,000 lpm at 7 bar at the monitor's outlet. Horizontal range is 360° by carrying handle with locking. Elevation is adjustable from -50° to +90° by handwheel. The monitor is equipped with a portable base and has two symmetric inlets DN65 with lock. The monitor has a base with two feet for maximum stability on the ground and a mooring ring to fix a strap (strap supplied).

Inlets	Outlet	Waterway Ø (mm)	Dimensions (mm)	Weight (kg)	Ref
2x 2.5" BSP male	2.5" NST-NH male	65	570 x 381 x 399	18,35	37390
2x SG DN65	2.5" NST-NH male	65		18,5	20344

hydraulic actuator

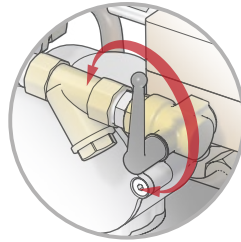
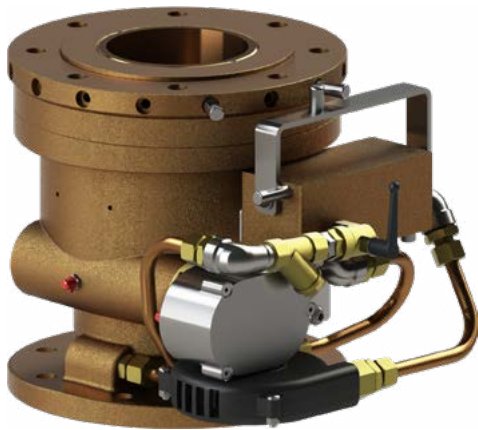

Shutoff valve and oscillation speed adjustment. Easy maintenance of the filter in the actuator

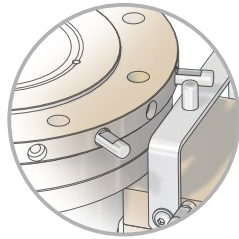

Adjustment stops of the angular stroke with 20° incrementation

Maximum working pressure: PN16
Material: stainless steel, bronze
Opening: by valve
Speed adjustment: by valve
Horizontal movement: on 360°, automatic sweeping
Filter : YES

Our DN100 hydraulic actuator was designed to offer more oscillating opportunities for fixed monitors.

It is made of bronze with screws in stainless steel.

The oscillation angles are easily adjustable from 20° to 360° (with 20° incrementation).

It can be equipped with a flange DN100 PN16 or 4" ASA150 for in-and outlets.



Inlet	Outlet	Speed	Dimensions (mm)	Weight (kg)	Ref
Flange DN100 PN16	Flange DN100 PN16	0,9 rpm @ 10 bar 0,7 rpm @ 7 bar	327 x 256 x 239	41,9	33375



DN65 fixed monitor, in bronze



Maximum working pressure: PN16
Material: bronze
Horizontal movement: from -170° to +170°
Horizontal adjustment: motorised and spare screw
Vertical movement: from -37° to +85°
Vertical adjustment : motorised and spare screw
Power supply: 24V CC
Speed : 22°/s

Options: flange, outlet equipment, control system

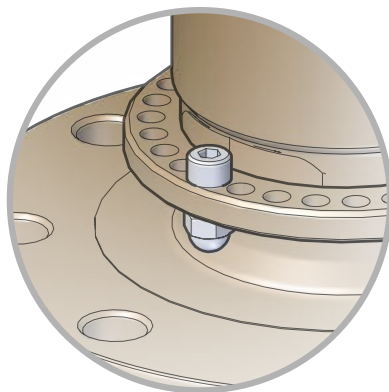

Stops to adjust vertical and horizontal range

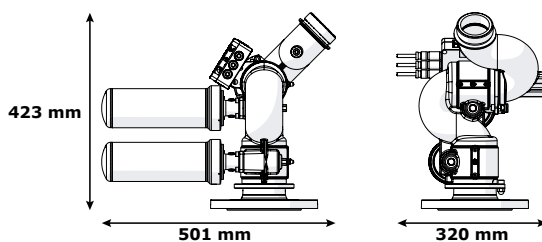

This compact monitor offers a wide horizontal rotation angle in a small volume. Its original design has made this monitor an essential tool for firefighting in the hardest marine or port environments. Associated to several outlets accessories (diffuser, self-educing diffuser, water branchpipe, water-foam branchpipe, blabbermouth) this monitor allows a flow rate up to 2,000 lpm at 7 bar at the monitor's outlet. Moreover, the monitor nozzle and all accessories are all PN16, so it can support inconvenient high pressure due to manipulation mistakes. Completely electrified (POK EasyDrive© Compatible) and equipped with high performance motors, it can be controlled by radio or wire remote controlled allowing extremely fast, precise and progressive movements.

Inlet	Outlet	Waterway Ø (mm)	Dimensions (mm)	Weight (kg)	Ref
Flange 3" ASA150	2.5" NST-NH male	65	501 x 320 x 423	28,6	29373
Flange 4" ASA150	2.5" NST-NH male	65	501 x 320 x 423	30,4	29374



Self-educing diffuser, made of stainless steel and bronze



This self-educing diffuser is made of stainless steel and bronze, and was designed to be used in the marine environment. Its aspiration can be calibrated at 3% or 6%. The stream pattern is selectable by capstan (straight stream, attack spray, wide angle spray).

Maximum working pressure: PN16
Material: stainless steel and bronze
Stream types: straight jet, flashover and wide angle spray
Suction percentage: 3 or 6%
Expansion rate: approx. x10

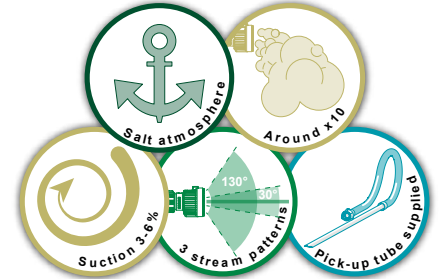

Inlet	Flow rate (lpm)	Working pressure (bar)	Dimensions (mm)	Weight (kg)	Ref.
2.5" BSP male	1500	7	Ø244 x 258	7,90	25734
2.5" NST-NH female	2000	7	Ø244 x 188	7,81	20141
2.5" NST-NH female	2000	7		7,77	22347
2.5" NST-NH female	3000	7		7,77	22348

DEBIKA-INOX



This diffuser with selectable flow rate and selectable flow pattern diffusers (straight stream, attack spray, wide angle spray) DebiKa-Inox is made of stainless steel. It is designed to be used with POK monitor nozzles to obtain a quality spray and performance for an efficient firefighter.

Maximum working pressure: PN16
Material: stainless steel (and bronze)
Stream types: straight jet, flashover and wide angle spray
Head: smooth (3000 lpm), cut teeth (6000 lpm)



Inlet	Flow rate (lpm)	Working pressure (bar)	Dimensions (mm)	Weight (kg)	Ref.
2.5" BSP male	1000 - 2000 - 3000	7	Ø122 x 151	5,50	15862
3.5" NST-NH female	2000 - 3000 - 4000 - 5000 - 6000	7	Ø261 x 347	16,00	30845



Self educating diffuser, made of stainless steel and bronze



Our range of self-educing diffusers (2,000 or 3,000 lpm) are made of stainless steel and bronze for a PN16 use.

The aspiration is calibrated to 3 or 6% and are delivered with a pick-up tube. It is intended to be mounted at the output of our POK EasyDrive monitors. The monitoring of the stream shape is made using an electric jack equipped with two stop switches.

Jack equipped with two stop switches. The cylinders also have a relative position sensor used by our control systems when servo control is required.

Maximum working pressure: PN16
Material: stainless steel and bronze
Stream types: straight jet, flashover and wide angle spray
Stream adjustment: motorised
Supply: 24V CC
Suction percentage: 3 or 6%
Expansion rate: approx. x10

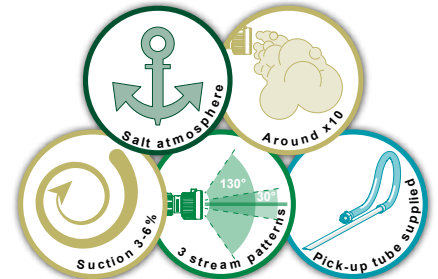

Inlet	Flow rate (lpm)	Working pressure (bar)	Dimensions (mm)	Weight (kg)	Ref.
2.5" NST-NH female	2000	6	258 x 122 x 122	9,58	22343
2.5" NST-NH female	3000	6	258 x 122 x 122	9,58	22344

AUTOKADOR, made of stainless steel



The Autokador automatic constant pressure diffusers are made of stainless steel. They provide a self-regulating range of 500 to 6,000 lpm at 7 bar. The stream shape is achieved by a fixed gear. It is intended to be mounted at the output of our POK EasyDrive monitors. The monitoring of the stream shape is made using an electric jack equipped with two stop switches. The cylinders also have a relative position sensor used by our control systems when servo control is required.

Maximum working pressure: PN16
Material: stainless steel
Stream types: straight jet, flashover and wide angle spray
Stream adjustment: motorised
Supply: 24V CC
Head: cut teeth

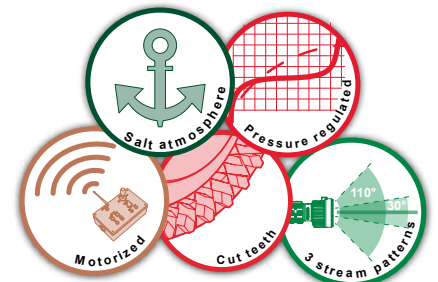

Inlet	Regulated flow rate (lpm)	Working pressure (bar)	Dimensions (mm)	Weight (kg)	Ref.
1.5" NST-NH female	from 500 to 1000	7	183 x 132 x 87	4,40	19023
2.5" NST-NH female	from 1000 to 3000	7	228 x 167 x 130	6,51	19063
3.5" NST-NH female	from 2000 to 6000	7	349 x 217 x 160	18,00	30851



Water branchpipe made of stainless steel with blabbermouth



Water branchpipes are designed to be mounted on monitor with 2.5" outlet. It allows a water/foam use at 1,400 lpm at 7 bar in marine or corrosive environment.

Maximum working pressure: PN16
Material: stainless steel
Blabbermouth adjustment: handwheel

Inlet	Flow rate (lpm)	Working pressure (bar)	Dimensions (mm)	Weight (kg)	Ref.
2.5" BSP male	1400	7	725 x 265 x 77	4,83	20247



Self educating water foam branchpipe in stainless steel



The self educating water foam branchpipe in stainless steel has a flow rate from 500 to 19,000 lpm at 7 bar. It is delivered with suction tube.

Maximum working pressure: PN16
Material: aluminium alloy
Surface treatment: polyester coating
Expansion rate: approx. x10
Suction percentage: from 0 to 6%
Suction hose supplied: YES

Options: blabbermouth

Inlet	Suction coupling	Flow rate (lpm)	Working pressure (bar)	Dimensions (mm)	Weight (kg)	Ref.
1.5" NST-NH female	GFR DN20 male	500	12	688 x 115 x 60	2,57	21686
3" BSP female	1" BSP male	1400	7	782 x 123 x 110	4,76	19955
2.5" BSP male	1" BSP male	1400	7	767 x 110 x 84	3,83	20507
2.5" BSP male	1.5" BSP male	2000	7			07768
2.5" BSP male	1.5" BSP male	2800	7	848 x 137 x 120	5,83	22067
2.5" BSP male	1.5" BSP male	3000	7			07769
3" BSP female	1.5" BSP male	3000	7	874 x 122 x 110	5,26	12873
4" BSP female	SG DN50	6000	7	1589 x 248 x 268	20,70	15906
Flange 4" ASA150	Storz B/75	9000	7	1582 x 286 x 229	34,30	15563
6" NST-NH female	SG DN65	11000	7			38071
Flange 6" ASA150	2x Storz B/75	19000	7			17348
Flange DN150 PN16	2x Storz B/75	19000	7	1786 x 410 x 285	37,50	17316

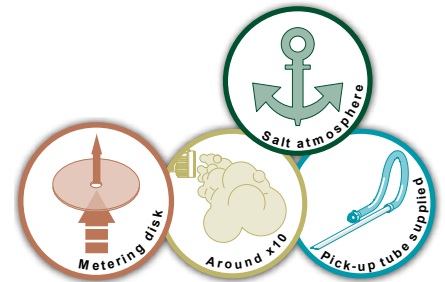

Powder foam branchpipes (patented)



The powder foam branchpipes are made of hard anodised aluminium alloy with polyester coating, combines two functions: powder branchpipe and foam branchpipe. The combination of the two devices operating simultaneously has the advantage of significantly improving the throw range of the powder nozzle and generates unsurpassed efficiency in extinguishing oil fires and is used by the French navy.

Maximum working pressure: PN16
Material: aluminium alloy
Expansion rate: approx. x10

Options: blabbermouth

Inlet	Powder coupling	Foam flow rate (lpm)	Powder flow rate (kg/s)	Working pressure (bar)	Dimensions (mm)	Weight (kg)	Ref.
2.5" BSP female	1.5" BSP female, swivel	2000	10 kg/s	7	748 x 130 x 177	5,979	17294
2.5" NST-NH female		2000	10 kg/s	7		6,30	18703
2.5" BSP female	1.5" BSP female, swivel	1200	10 kg/s	7	579 x 134 x 177	5,32	19100
2.5" BSP female	1.5" BSP female, swivel	1500	10 kg/s	7	579 x 134 x 177	5,32	20758
2.5" BSP female	1.5" BSP female, swivel	4000	10 kg/s	7	748 x 177 x 130	5,91	21632
3.5" NST-NH female	Storz B/75, swivel	8000	20 kg/s	7	806 x 204 x 287	14,70	21780



Eductors "MIXY-EDUCTOR" in bronze with metering device

With control valve and metering device

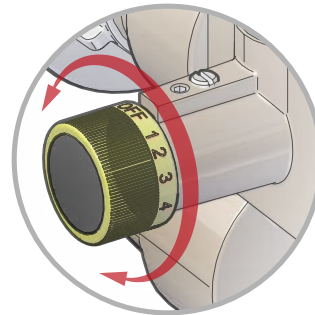
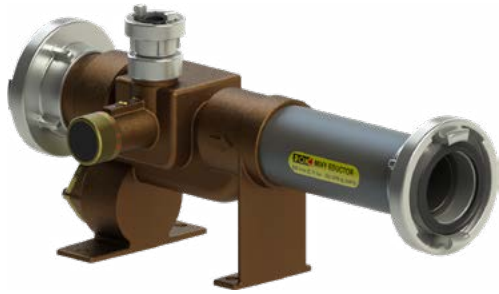

Setting of the dosing percentage via the indexed metering device

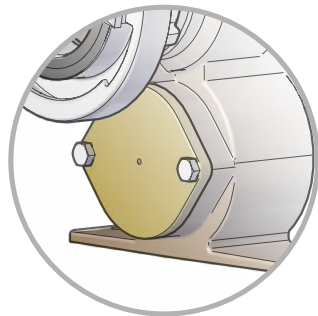

Control valve integrated to the eductor

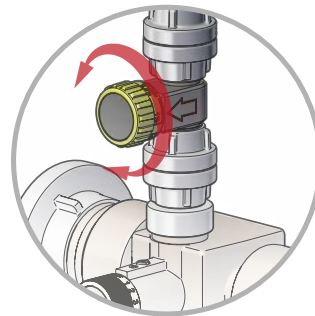

Optional: the eductors "MIXY EDUCTOR" of 200 and 400 lpm can be equipped with a metering device with suction percentages of 0,1%, 0,5% and 1%.

Our range of foam "MIXY EDUCTORS" operate according to the Venturi principle. As the pressurized water passes through the tip of the convergent pipe, a suction effect is created and the foam concentrated liquid is drawn up. The eductor is fitted with a non-return valve and a polyethylene ball valve, which prevents water from flowing back into the emulsifier tank. The metering orifice regulates the concentration flow and thus determines the percentage of the foam liquid from 0% to 6%.

The control valve allows a constant dosage while pressure varies.

Our range of eductors are used with flow rates from 200 to 800 lpm and various possible connections: threaded BSP or NST-NH or standardised couplings. Construction in bronze for the body and aluminium alloy for couplings.

Working pressure: PN16
Material: bronze
Body type: moulded
Non-return valve: yes
Control valve: yes
Pressure loss: 35%
Supplied with pick-up tube: yes

Options: metering device 0,1%, 0,5% and 1% for 200 and 400 lpm eductors.

Inlet	Outlet	Suction percentage adjustment	Flow rate / Working pressure				Dimensions (mm)	Weight (kg)	Ref.
			lpm	Bar	GPM	PSI			
2" BSP male	2" BSP male	0, 1%, 2%, 3%, 4%, 5%, 6%	200	10	60	140	309 x 171 x 177	6,04	18756
Storz C/52	Storz C/52	0, 1%, 2%, 3%, 4%, 5%, 6%	200	10	60	140	378 x 171 x 177	6,62	18755
DSP DN40	DSP DN40	0, 1%, 2%, 3%, 4%, 5%, 6%	200	10	60	140	405 x 171 x 185	7,05	18757
Instantaneous BS336	Instantaneous BS336	0, 1%, 2%, 3%, 4%, 5%, 6%	200	10	60	140	406 x 171 x 192	8,61	16083
1.5" NST-NH female	1.5" NST-NH male	0, 0,4%, 1%, 3%, 6%	200	10	60	140	372 x 171 x 177	6,43	18764
1.5" NST-NH female	1.5" NST-NH male	0, 0,4%, 1%, 3%, 6%	300	10	95	140	372 x 171 x 177	6,43	18765
2" BSP male	2" BSP male	0, 1%, 2%, 3%, 4%, 5%, 6%	400	10	125	140	309 x 171 x 177	6,04	18759
Storz B/75	Storz B/75	0, 1%, 2%, 3%, 4%, 5%, 6%	400	10	125	140	384 x 171 x 177	8,39	18758
DSP DN65	DSP DN65	0, 1%, 2%, 3%, 4%, 5%, 6%	400	10	125	140	410 x 171 x 185	6,75	18760
Instantaneous BS336	Instantaneous BS336	0, 1%, 2%, 3%, 4%, 5%, 6%	400	10	125	140	405 x 171 x 195	6,96	16084
2.5" NST-NH female	2.5" NST-NH male	0, 0,4%, 1%, 3%, 6%			200	140			18766
2.5" BSP male	2.5" BSP male	0, 1%, 2%, 3%, 4%, 5%, 6%	800	10	250	140	453 x 198 x 225	9,25	18762
Storz B/75	Storz B/75	0, 1%, 2%, 3%, 4%, 5%, 6%	800	10	250	140	528 x 198 x 217	10,10	18761
DSP DN65	DSP DN65	0, 1%, 2%, 3%, 4%, 5%, 6%	800	10	250	140	535 x 198 x 225	9,87	18763

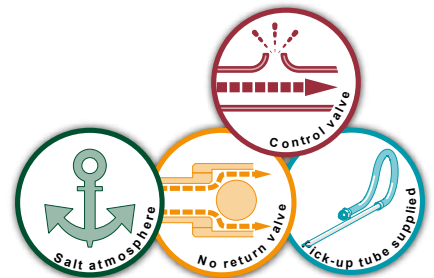

"ULTRA-FOAM" eductors without bypass, in bronze, with calibrated orifices



Working pressure: PN16
 Material: bronze
 Surface treatment: brut
 Non-return valve: yes
 Supplied with pick-up tube: yes

These "ULTRA-FOAM" eductors without bypass are made entirely in bronze for a saline environment. The regulation of dosage is obtained by calibrated orifices having the function of non-return valve.
 Our ultra-foam eductors are easily dismantled for a better cleaning and maintenance. Every product is furnished with a pick up tube and a suction pipe.

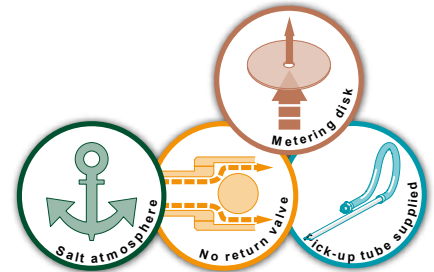

Inlet	Outlet	Flow rate / Working pressure				Dimensions (mm)	Weight (kg)	Ref.
		lpm	Bar	GPM	PSI			
1.5" NPSH female	1.5" NPSH male	225	10	60	200	290 x 62 x 128	2,35	21867
1.5" NPSH female	1.5" NPSH male			90	200	290 x 62 x 128	2,35	21871

"ULTRA-FOAM" eductors without bypass, in bronze, with metering device



Adjustment of dosage done via the indexed metering device

Working pressure: PN16
 Material: bronze and stainless steel
 Surface treatment: brut
 Suction percentage: 0.4, 1, 3 and 6%
 Non-return valve: yes
 Supplied with pick-up tube: yes

These "ULTRA-FOAM" eductors without bypass are made entirely in bronze for a saline environment. The regulation of dosage during operation is obtained thanks to an indexed metering device.
 Our ultra-foam eductors are easily dismantled for a better cleaning and maintenance. Every product is furnished with a pick up tube and a suction pipe.

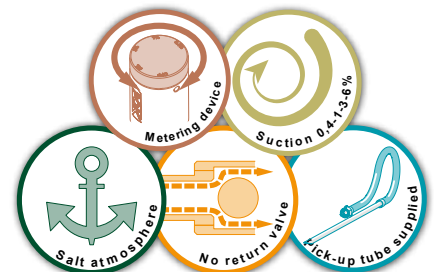

Inlet	Outlet	Suction percentage adjustment	Flow rate / Working pressure				Dimensions (mm)	Weight (kg)	Ref.
			lpm	Bar	GPM	PSI			
M56 x 400 female (UNI 811)	M56 x 400 male (UNI 810)	0,4%, 1%, 3%, 6%	360	10	95	200	301 x 75 x 181	3,00	21875

Eductors in stainless steel, with metering device

In compliance with norms
 French: NFE 29-201 and NFE 29-203
 German: DIN 201
 American: ANSI B 16-5
 International: ISO 2084

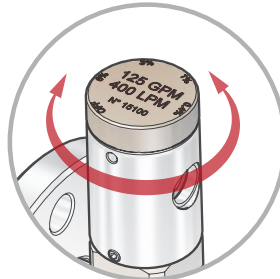

Suction percentage set with metering device for 1, 2, 3, 4, 5 and 6%

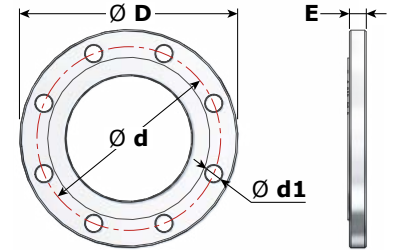

Description	Dimensions				
	D	d	E	d1 - Thread	# of holes
ISO DN40 PN16	150	110	16	18 - M16	4
ISO DN50 PN16	165	125	18	18 - M16	4
ISO DN65 PN16	185	145	18	18 - M16	4
ISO DN80 PN16	200	160	20	18 - M16	8
ISO DN100 PN16	220	180	20	18 - M16	8
ISO DN150 PN16	285	240	22	22 - M20	8
3" ASA150	190,5	152,4	23,9	19 - M16	4
4" ASA150	228,6	190,5	23,9	19 - M16	8

Working pressure: PN16
 Material: stainless steel
 Pressure loss: 40%
 Suction percentage: 0, 0.4, 1, 3 and 6%
 Non-return valve: yes
 Supplied with pick-up tube: yes

Our range of eductors with a metering device are made in stainless steel. The metering device allows to modify the suction percentage (0, 0.4, 1, 3 and 6%) during the use of the foam equipment. Our range of eductors works with flow rates going from 200 to 5,000 lpm and various connections: DN50 to DN150 (depending on the flow rate) PN16 or ASA150.

Inlet flange	Outlet flange	Suction coupling	Flow rate / Working pressure				Dimensions (mm)	Weight (kg)	Ref.
			lpm	Bar	GPM	PSI			
DN50 PN16	DN50 PN16	1/2" BSP female	200	10	60	140		22187	
DN50 PN16	DN50 PN16	1/2" BSP female	400	10	125	140	8,00	21995	
DN65 PN16	DN65 PN16	1/2" BSP female	400	10	125	140	9,63	22180	
DN65 PN16	DN65 PN16	1" BSP male	800	10	250	140	11,94	22228	
DN80 PN16	DN80 PN16	1" BSP male	1000	10	300	140	13,42	22006	
3" ASA150	3" ASA150	1" BSP male	1000	10	300	140	14,10	22001	
DN100 PN16	DN100 PN16	1.5" NPT female	1200	10				22007	
4" ASA150	4" ASA150	1.5" NPT female	1200	10				22008	
DN100 PN16	DN100 PN16	1.5" NPT female	1500	10	400	140		22169	
4" ASA150	4" ASA150	1.5" NPT female	1500	10	400	140		22170	
DN100 PN16	DN100 PN16	1.5" NPT female	2000	10	600	140		22183	
4" ASA150	4" ASA150	1.5" NPT female	2000	10	600	140		22184	
DN100 PN16	DN100 PN16	1.5" NPT female	3000	10	800	140		22185	
4" ASA150	4" ASA150	1.5" NPT female	3000	10	800	140		22186	
DN150 PN16	DN150 PN16	Storz B/75	4000	10			32,78	21558	
DN150 PN16	DN150 PN16	Storz B/75	5000	10				22009	

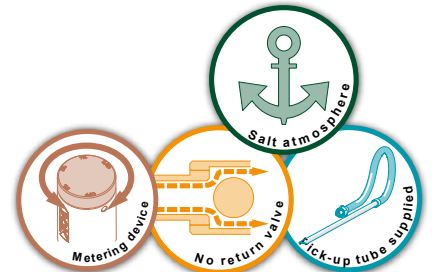

Foam discharge heads

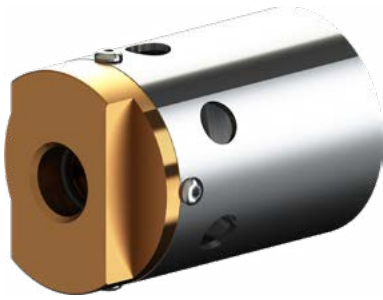

Working pressure: PN16
Material: stainless steel and bronze
Surface treatment: Untreated
Expansion: approx. x20 to x30

These discharge heads for fixed installations are made in stainless steel and bronze to resist to a corrosive environment. The mesh in stainless steel allows an expansion of 20 or 30.



Inlet	Water flow rate (lpm)	Working pressure	Dimensions (mm)	Weight (kg)	Ref.
1/2" BSP female	20	6	90 x Ø61	0,68	14018
3/4" BSP female	75	6	115 x Ø76	0,67	12371



"COMBIPOWDER" powder-foam nozzle (patented)



Working pressure: PN16
Material: aluminium alloy
Surface treatment: polyester coating and hard anodisation
Body type: moulded
Valve type: ball valve
Operation: by lever
Pistol grip type: yes
Expansion: approx. x10
Range: 27m (measure made by the French Navy)

Our range of "COMBIPOWDER" powder foam nozzle are made entirely in aluminium alloy. This nozzle combines two functions: a powder nozzle with flow rate of 5 Kg/s and a 400 lpm foam nozzle.

The combination of the two devices operating simultaneously has the advantage of significantly improving the distance of the powder nozzle and generates unsurpassed efficiency in extinguishing oil fires.

A large number of inlet connections can be provided: threaded BSP or NST-NH or standardised couplings.

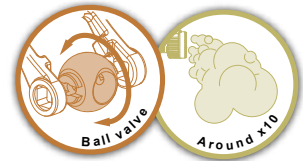

Inlets	Flow rate water (lpm)	Flow rate powder (kg/s)	Working pressure (bar)	Dimensions (mm)	Weight (kg)	Ref.
2x 2" BSP male	400	5	6	341 x 126 x 315	3,36	14966
2x 1" NST-NH female	400	5	6	401 x 126 x 315	4,15	16028
2x 1.5" NST-NH female	400	5	6	373 x 126 x 315	3,80	16029
2x 1" NPSH female	400	5	6	401 x 126 x 315	4,15	16030
2x 1.5" NPSH female	400	5	6	405 x 126 x 315	4,14	16031
2x Storz DN38	400	5	6	365 x 126 x 315	3,67	16032
2x SG DN40 swivel, in bronze	400	5	6	447 x 126 x 315	5,09	16033

"SNOW COAT" DN500 high expansion foam generator

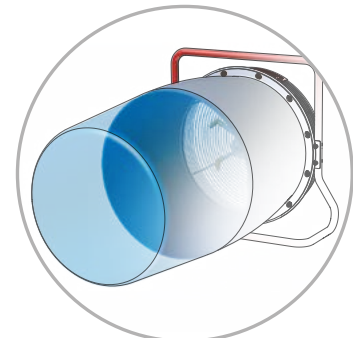
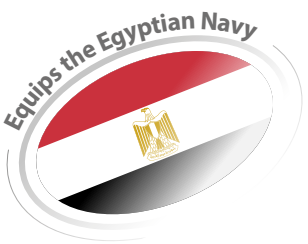

Generator with net to optimize the expansion

Working pressure: PN16
Material: aluminium alloy, stainless steel and brass
Surface treatment: polyester coating
Expansion: approx. x350

This generator has six injectors that bring the device into rotation similar to rotating fan blades, thus blowing the premix through the net.

It offers a flow rate of 220 lpm at 6 bar.

It allows a premix of 3% and expansion rate of 350.

A large number of inlet connections can be provided: threaded BSP or NST-NH or standardised couplings.



Inlet	Flow rate (lpm)	Working pressure (bar)	Diameter (mm)	Dimensions (mm)	Weight (kg)	Ref.
DSP DN40	220	6-7	500	617 x 227 x 667	17,70	18020

High expansion foam generators MISTRAL - DN300

Adjustable equipment
3 functions
 High expansion foam generator
 Misting and ventilation
 Discharge of fumes and smoke

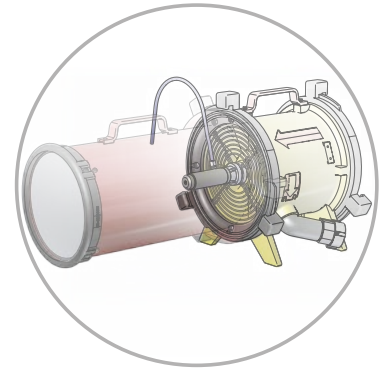

Example of use with self-educing device and foam expansion with mesh

Our foam generator "MISTRAL 300" is made primarily of aluminium alloy. The stainless steel turbine can operate for more than twelve hours without interruption. It is usually not the case of similar models equipped with plastic turbines. The water supply is protected by a filter of high resistance and to protect the turbine against anything that could damage it. With self-educing function and foam tube (optional) the "MISTRAL 300" is a foam generator of high expansion (about 200) with a throw range higher than 10 meters at an operating pressure of 7 bar.

Inlet ventilation coupling: ZAG DN300 (norm NF S 61-707) in aluminium alloy.

Working pressure: PN16
Material: aluminium alloy
Surface treatment: polyester coating
poignée de portage: yes

Options: self educating device, foam expansion with mesh

Inlet	Outlet	Working pressure (bar)	Diameter (mm)	Dimensions (mm)	Weight (kg)	Ref.
1.5" NST-NH female	1.5" NST-NH male	7	300	338 x 407 x 409	17,70	11521



High expansion foam generator DN500

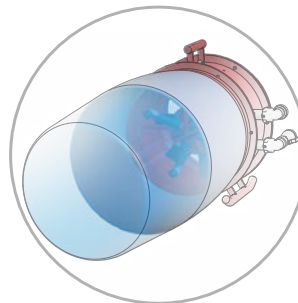

Inlet and outlet with swivel elbow and 1/4 turn valve at the inlet.

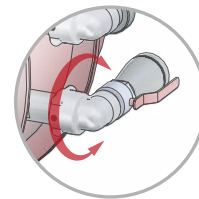

Inlet and outlet with swivel elbow and 1/4 turn valve at the inlet

Our high expansion portable foam generator DN500 is made entirely in aluminium alloy. It is used either with high expansion foam generator or without its extractor function as a simple fan.

It comes in two versions: 500 expansion or variable expansion from 500 to 1,200. The flow rate is 225 lpm at 6-7 bar. The foam concentrate is introduced in the device via a pick-up tube. A large number of inlet connections can be provided: threaded BSP or NST-NH or standardised couplings. This generator offers high performance and is easily transportable.

Working pressure: PN16
Material: aluminium alloy and stainless steel
Surface treatment: polyester coating and hard anodisation
Expansion: approx. x500 or from x500 to x1200

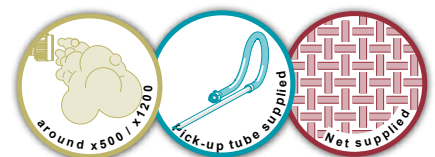

Inlet	Outlet	Expansion	Working pressure (bar)	Dimensions (mm)	Weight (kg)	Ref.
2" BSP male	2" BSP male	500	6-7			07592
2" BSP male	2" BSP male	500 to 1200	6-7			01487

2-way dividers with ball valves - US Navy "BIPOK"



Working pressure: PN16
Valve type: ball valve
Operation: by lever
Material: bronze and stainless steel
Body type: moulded

Options: couplings inlet/outlet.

Our divider « US NAVY Bipok » is made of bronze. It is equipped with two ball valve shutoffs and stabilising feet. There is almost no pressure loss thanks to its full waterway. It is equipped with one inlet female threaded 2.5" NST-NH and two outlets male threaded 1.5" NPSH. This divider equips the US Navy: 481 units ordered in 2007.

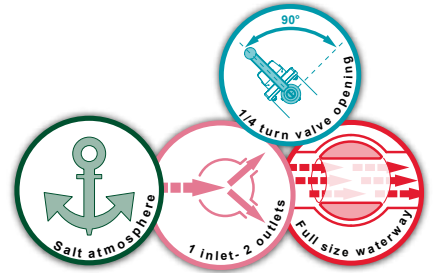

Inlet	Outlets	Dimensions (mm)	Weight (kg)	Ref.
2.5" NST-NH female	2x 1.5" NPSH male	184 x 181 x 125	3,35	17030



Mobile-eductor



The mobile eductor is used to empty cargo holds of a ship. It is made of aluminum alloy (that undergoes thermic treatment), highly resistant, and the functional parts are made of stainless steel.

Technical specifications: the mobile eductor operates according to the venturi principle. The passage of water under pressure in the ducts converging and diverging creates a vacuum which causes the suction of the liquid to evacuate.

A ring is available for attaching a carabiner.

The suction capacity, or the suction flow, depends on:

- the water pressure to drive the input of the device,
- the geometric height suction (the level difference between the watertable (to absorb) and the mobile eductor).



Description	Inlet	Outlet	Aspiration	Dimensions (mm)	Weight (kg)	Ref.
Mobile Eductor of 3 tons / hour	SG DN25	SG DN40	SG DN40	349 x 70 x 133	1,49	07649
Mobile Eductor of 5 tons / hour	SG DN25	SG DN40	SG DN40	349 x 70 x 133	1,49	07647
Mobile Eductor of 15 tons / hour	SG DN40	SG DN65	SG DN65	622 x 122 x 238	4,27	07855

Strainers, made of stainless steel

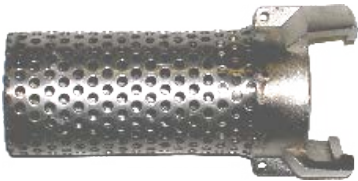

Description	Dimensions (mm)	Weight (kg)	Ref.
With SG DN40	70 x 54 x 164	0,56	01600
With SG DN50			01601
With SG DN65	104 x 82 x 268	1,35	01602
With SG DN65			09524



Hose reel in stainless steel - Without hose - DN25

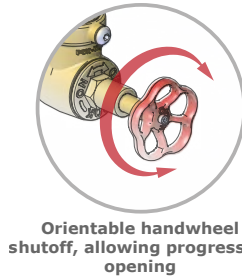

Maximum working pressure: PN16
Material: stainless steel
Shutoff: with handwheel shutoff

Our rotating swinging hose reels DN25 for wall installation have the advantage to rotate easily 180°. Our hose reels have a capacity of 30 meters long of semi-rigid hoses (delivered without hose). They are equipped with brass handwheel shutoff, allowing a progressive opening. These stainless steel hose reels equip French nuclear submarines.



Hose capacity	Inlet	Dimensions (mm)	Weight (kg)	Ref.
DN25 - 30 m	1" BSP male	498 x 337 x 705	16,34	21922

Foam hose reel - 200 lpm - DN33 - stainless steel tank

Can be equipped with selectable suction eductor

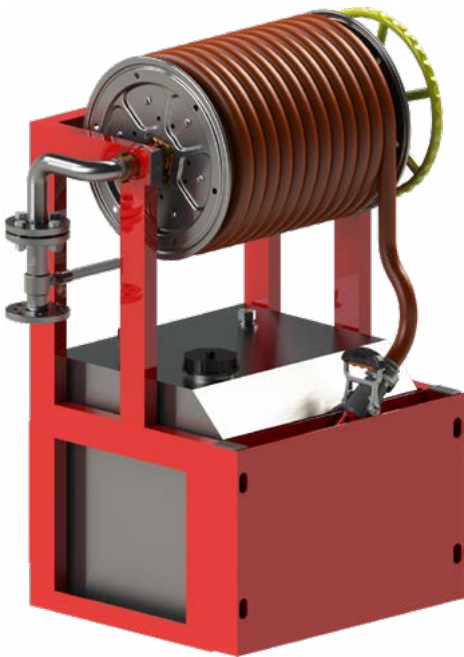

Foam hose reel for the protection of French and foreign military vessels with 200 lpm flow rates at a working pressure of 10 bar. Including foam agent stainless steel tank of 200L capacity, with filling orifice.

Our foam station is composed of a DN33 semi-rigid hose, 30 meters long. Operated by a handwheel.

It is equipped with an eductor made of aluminium alloy (3% aspiration), anti return valve and a 200 lpm low foam hand nozzle made of anodised aluminium alloy.

Construction made of aluminium alloy, stainless steel and bronze.

Maximum working pressure: PN16
Tank:
Material: stainless steel

Nozzle:
Material: aluminium alloy
Surface treatment: polyester coated and hard anodisation
Shutoff: with ball valve
Opening: by operating handle
Foam expansion: approx. x10

Eductor:
Material: stainless steel
Suction percentages: 3%
Non-return valve: yes

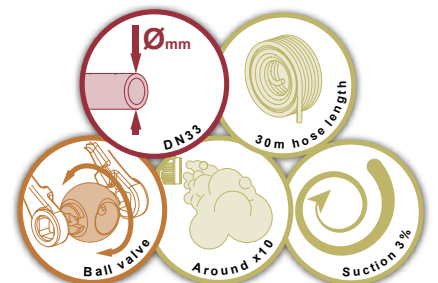

Hose Ø (mm)	Hose length (m)	Tank capacity (L)	Flow rate (lpm)	Working pressure (bar)	Dimensions (mm)	Weight (kg)	Ref.
DN33	30	200	200	10	987 x 677 x 1364	102	15814

Foam hose reel - 60 lpm - DN25 - Stainless steel tank

Can be equipped with selectable suction eductor



Foam hose reel for the protection of French and foreign military vessels with 60 lpm flow rates at a working pressure of 7 bar. Including foam agent stainless steel tank of 30L capacity, with filling orifice.

Our foam station is composed of a DN25 semi-rigid hose, 30 meters long depending on the model. Operated by handwheel.

It is equipped with an eductor made of aluminium alloy (3% aspiration*), anti return valve and a 400 lpm low foam hand nozzle made of anodised aluminium alloy.

Construction made of aluminium alloy, stainless steel and bronze.

Maximum working pressure: PN16

Tank:

Material: stainless steel

Nozzle:

Material: aluminium alloy

Surface treatment: polyester coated and hard anodisation

Shutoff: with ball valve

Opening: by operating handle

Eductor:

Material: stainless steel

Suction percentages: 3%

Non-return valve: yes

Hose Ø (mm)	Hose length (m)	Tank capacity (L)	Flow rate (lpm)	Working pressure (bar)	Dimensions (mm)	Weight (kg)	Ref.
DN25	30	30	60	7	695 x 480 x 950	69	28317

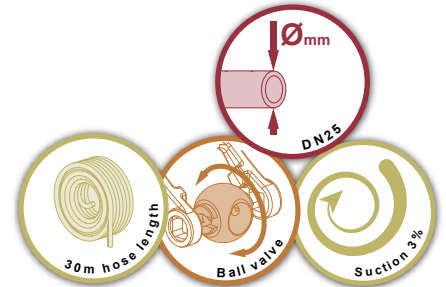

Foam station - 200 lpm - Stainless steel tank

Can be equipped with selectable suction eductor



Foam station for the protection of French and foreign military vessels. Composed of a foam agent stainless steel tank of 200L capacity, with filling orifice.

Our foam station is equipped with two selectable suction eductor made of bronze, with anti return valve.

Maximum working pressure: PN16

Tank:

Material: stainless steel

Eductors:

Material: bronze

Suction percentages: 1, 2, 3, 4, 5 and 6%

Non-return valve: yes

Tank capacity (L)	Flow rate (lpm)	Working pressure (bar)	Dimensions (mm)	Weight (kg)	Ref.
200	2x 400	10	630 x 610 x 976	88	20549

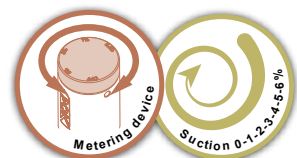

Half-couplings with locking ring, with multi-serrated hose shank

In compliance with norm
NF S 61-701

In compliance with norm
NF E 29-572



Description	Aluminium alloy PN20		Bronze PN20		Stainless steel PN20	
	Weight (kg)	Ref	Weight (kg)	Ref	Weight (kg)	Ref
DN15, multi-serrated hose shank Ø20			0,12	04200	0,11	04400
DN20, multi-serrated hose shank Ø25	0,07	04001	0,15	04201	0,18	04401
DN25, multi-serrated hose shank Ø30	0,09	04002*	0,21	04202	0,25	04402
DN32, multi-serrated hose shank Ø35	0,13	04003*	0,26	04203	0,30	04403
DN40, multi-serrated hose shank Ø45	0,19	04004*	0,48	04204	0,57	04404
DN50, multi-serrated hose shank Ø55	0,32	04005*	0,70	04205	0,94	04405
DN50, multi-serrated hose shank Ø55 (long version)					0,99	02909
DN65, multi-serrated hose shank Ø70	0,44	04006*	0,95	04206	1,35	04406
DN65, multi-serrated hose shank Ø70 (long version)					1,45	02886
DN80, multi-serrated hose shank Ø90	0,86	04007*	1,58	04207	2,16	04407
DN100, multi-serrated hose shank Ø110	1,11	04008*	2,55	04208	3,20	04408
DN150, multi-serrated hose shank Ø152	3,25	04009				

(* French Navy Homologation N°6596/46 STCM)

Half-couplings with locking ring, reduced multi-serrated hose shank

In compliance with norm
NF S 61-701

In compliance with norm
NF E 29-572



Description	Aluminium alloy PN20		Bronze PN20		Stainless steel PN20		Polypropylene PN6	
	Weight (kg)	Ref	Weight (kg)	Ref	Weight (kg)	Ref	Weight (kg)	Ref
DN32, reduced multi-serrated hose shank Ø32	0,11	04011						
DN40, reduced multi-serrated hose shank Ø25	0,19	04010						
DN40, reduced multi-serrated hose shank Ø35	0,19	04012	0,43	04212				
DN40, reduced multi-serrated hose shank Ø40 with collar	0,21	04013	0,43	04213	0,65	04413		
DN50, reduced multi-serrated hose shank Ø50 with collar	0,36	04014						
DN50, reduced multi-serrated hose shank Ø51			0,64	04214	0,98	04414		16112
DN50, reduced multi-serrated hose shank Ø55								16113
DN65, reduced multi-serrated hose shank Ø65 with collar	0,53	04015	0,96	04215	1,45	04415		
DN80, reduced multi-serrated hose shank Ø75 with collar	0,93	04016	1,50	04216	2,32	04416		
DN80, reduced multi-serrated hose shank Ø80 with collar	0,98	04017	1,58	04217				
DN80, reduced multi-serrated hose shank Ø81 (lisse)					2,33	04417		
DN100, reduced multi-serrated hose shank Ø100 with collar	1,17	04018			3,39	04418		
DN100, reduced multi-serrated hose shank Ø101			2,35	04128				
DN100, reduced multi-serrated hose shank Ø105	1,10	03258						

Half-coupling with locking ring, with double-ribbed hose shank



In compliance with norm
NF S 61-701

In compliance with norm
NF E 29-572

Description	Aluminium alloy PN20		Polypropylene PN6	
	Weight (kg)	Ref	Weight (kg)	Ref
DN40, double-ribbed hose shank Ø45				16111
DN50, double-ribbed hose shank Ø50	0,34	04021		
DN50, double-ribbed hose shank Ø55	0,30	04028		
DN65, double-ribbed hose shank Ø63,5	0,34	04022		
DN65, double-ribbed hose shank Ø75	0,50	04023		
DN100, double-ribbed hose shank Ø100	0,98	04025		
DN100, double-ribbed hose shank Ø110	1,08	04026		
DN100, double-ribbed hose shank Ø125	1,55	04027		
DN150, double-ribbed hose shank Ø152 with collar	3,98	01200		
DN150, double-ribbed hose shank Ø152 without collar	2,78	16376		

Half-coupling with locking ring, male thread



Description	Aluminium alloy PN20		Bronze PN20		Stainless steel PN20		Polypropylene PN6	
	Weight (kg)	Ref	Weight (kg)	Ref	Weight (kg)	Ref	Weight (kg)	Ref
DN15, 0.5" BSP male			0,10	04240	0,11	04440		
DN20, 0.75" BSP male	0,07	04041	0,15	04241	0,16	04441		
DN25, 1" BSP male	0,11	04042	0,19	04242	0,24	04442		
DN32, 1.25" BSP male	0,15	04043	0,34	04243	0,35	04443		
DN40, 1.5" BSP male	0,17	04044	0,35	04244	0,45	04444		16116
DN50, 2" BSP male	0,28	04045	0,58	04245	0,82	04445	0,15	20925
DN65, 2.5" BSP male	0,40	04046	0,82	04246	0,84	04446		
DN80, 3" BSP male	0,65	04047	1,13	04247	1,68	04447	0,33	20928
DN100, 4" BSP male	1,02	04048	1,96	04248	2,51	04448		
DN150, 6" BSP male	2,37	04049						
DN20, 1" BSP male			0,22	16273				
DN32, 1" BSP male					0,24	16576		
DN40, 1.25" BSP male							0,09	20922
DN40, ISO M45 x 150 male	0,17	16580						
DN40, 2" BSP male	0,27	04050						
DN50, 1.25" BSP male	0,37	16063						
DN50, 1.5" male	0,30	04051	0,72	04251				
DN65, 2" BSP male	0,45	04054		04254				
DN65, ISO M70 x 150 male	0,37	16180						
DN65, 3" BSP male	0,54	04053						
DN80, 2.5" BSP male	0,68	04052						
DN100, 3" BSP male	0,87	04058						

Half-coupling with locking ring, female thread



Description	Aluminium alloy PN20		Bronze PN20		Stainless steel PN20		Polypropylene PN6	
	Weight (kg)	Ref	Weight (kg)	Ref	Weight (kg)	Ref	Weight (kg)	Ref
DN15, 0.5" BSP female			0,14	04260	0,15	04460		
DN20, 0.75" BSP female	0,09	04061	0,22	04261	0,27	04461		
DN25, 1" BSP female	0,12	04062	0,30	04262	0,38	04462		
DN32, 1.25" BSP female	0,22	04063	0,39	04263	0,36	04463		
DN40, 1.5" BSP female	0,25	04064	0,54	04264	0,69	04464	0,14	22209
DN50, 2" BSP female	0,21	04065	0,51	04265	0,68	04465	0,16	22210
DN65, 2.5" BSP female	0,57	04066	1,12	04266		04466		
DN80, 3" BSP female	0,52	04067	1,04	04267	1,56	04467	0,45	22211
DN100, 4" BSP female	1,11	04068	2,54	04268	2,57	04468		16123
DN150, 6" BSP female	2,29	04069						
DN20, 1" BSP female			0,31	16274				
DN40, 0.75" BSP female					0,60	16748		
DN40, 1" BSP female	0,19	01835			0,57	16749		
DN40, ISO M35 x 150 female	0,18	16579						
DN40, 2" BSP female	0,34	04070						
DN50, 1.5" BSP female	0,30	04071	0,60	04271				
DN65, 1.5" BSP female	0,48	16577	0,84	16532				
DN65, 2" BSP female	0,43	04072	0,76	04272	1,15	16747		
DN65, 3" BSP female	0,63	04073						
DN80, 2" BSP female	0,78	04074	1,48	04275	2,09	16270	0,34	21035
DN80, 2.5" BSP female			1,32	04276	1,53	02918		
DN90, 3" BSP female						03509		
DN100, 2.5" BSP female	1,02	16525						
DN100, 3" BSP female		04078	2,62	04277	2,76	16690		

Half-coupling with locking ring, with helicoidal hose shank



Description	Aluminium alloy PN20		Bronze PN20		Stainless steel PN20	
	Weight (kg)	Ref	Weight (kg)	Ref	Weight (kg)	Ref
DN25, helicoidale hose shank Ø25						04432
DN32, helicoidale hose shank Ø32						04433
DN40, helicoidale hose shank Ø40	0,25	04034			0,69	04434
DN50, helicoidale hose shank Ø50	0,43	04035			1,22	04435
DN65, helicoidale hose shank Ø65	0,60	04036			1,55	04437
DN80, helicoidale hose shank Ø80	0,95	04037	1,97	04237	2,30	04438
DN100, helicoidale hose shank Ø100	1,33	04038	3,06	04238	3,68	04439

Caps with locking ring and chain



Description	Aluminium alloy PN20		Bronze PN20		Stainless steel PN20	
	Weight (kg)	Ref	Weight (kg)	Ref	Weight (kg)	Ref
DN15			0,14	04340	0,14	04540
DN20	0,08	04141	0,19	04341	0,20	04541
DN25	0,09	04142	0,20	04342	0,22	04542
DN32	0,11	04143	0,25	04343	0,26	04543
DN40	0,13	04144	0,34	04344	0,43	04544
DN50	0,21	04145	0,54	04345	0,65	04545
DN65	0,31	04146	0,90	04346	0,93	04546
DN80	0,48	04147	0,93	04347	1,41	04547
DN100	0,68	04148	1,68	04348	2,15	04548
DN150	1,04	04149				



Universal spanner wrench for couplings from DN20 to DN120

In aluminium bronze, anti-sparks.



Description	Weight (kg)	Ref.
Universal spanner wrench for couplings from DN20 to DN120	0,28	01977

"Deschamps" spanner wrench

This model equips most of the French firemen outside the capital. It has eleven functions : tightening couplings of nominal diameter 20 to 100, opening old and new EDF and GDF (the French energy and gas companies) boxes with 13 mm equilateral female triangle, opening hydrants with the 15,6 mm female square, opening windows and doors without handle with the female square 6,5 mm, opening of ventilation ducts and fire cabinets with the truncated pyramid square of 5x5 to 8x8 mm, opening aluminium locks of modern bathrooms with the screwdriver, opening dry standpipes with 12,5 mm female square, the loosening of nuts with the hexagone socket 13, 17, and 19 mm, and finally the bottle opener.



Description	Weight (kg)	Ref.
"Deschamps" spanner wrench	0,20	02438

1. Warranty

Our products are guaranteed for two years from the date of receipt. The warranty covers faults with the raw materials and any defect in the production such as those defined in articles 1641 and the following found in the French Civil Code. The cost of labour to eliminate these defects in our workshops is also covered. The warranty is limited to the replacement of the defective piece. You will not be able to receive monetary compensation. The cost of shipping is not covered under this warranty. The warranty does not apply if we are able to determine that the materials have been damaged by:

- Normal wear and tear from proper usage of the product
- Incorrect usage of the product
- Accidents caused by negligence
- Lack of proper attention to the product
- Failure to maintain effective upkeep of the product
- Not conforming to standards for using the product
- Altering the product to use it outside of its professional usages
- Improper storage of the product

2. Sales

When placing an order, the client accepts the present conditions. They can not be modified by any provision in favor of the buyer or his commercial interests. All first purchases must be accompanied with a bank statement permitting us to open an account. The order, including the client notes and any commitments made by our agents, are not valid until we have acknowledged receipt of the order. Orders which have a net cost before taxes of less than our minimum order price of 150 € will be increased at the fixed amount of 50 €.

3. Price

Our prices are established based on the rates in effect on the day the merchandise is shipped.

They are ex-Works Nogent-Sur-Seine (France), packing and freight charges in addition, even when we do advance payment of the freight.

4. Payment

Time allotted to pay any invoice has to be concluded with the sales department. In a case of late payment, interest will be charged from the due date. All disputes relating to the settlement of the order are under the jurisdiction of the Court of Commerce in Troyes (Tribunal de Commerce de Troyes). Our money orders or acceptances are neither novations nor exceptions from this jurisdiction clause, even in the case of a warranty claim or if there are several defendants. Payment for merchandise may not be changed or delayed due to any delays in delivery of merchandise. Any failure on the part of the buyer in the execution of the payment of one or more of the agreed-upon invoices with the supplier will cause the cancellation of the sale and will give the seller the right to reclaim the property. For amounts less than 250€, payment by bank transfer is demanded upon receipt of the invoice.

5. Shipping

The delivery time mentioned on the Acknowledgment of Receipt of Order is simply a prediction based on current conditions. Any delay will not be our responsibility. In the case of a major event (such as strikes, lock-outs, epidemics, requisition, war, revolution, or natural disaster), we will be released from any obligations taken under our Acknowledgement of Receipt of Order. Shipments are made according to the best rates of transport that we are able to find while also taking into account the quality of service. The cost of shipping and handling are charged to the customer regardless of any divisions of the order. All orders amounting to more than 600€, excluding taxes, will receive free shipping to the destination if the order is for France; this excludes the first order and opening of an account where free shipping is only given for orders over 1525€, excluding taxes. All the orders for export are ex-Works Nogent-Sur-Seine (France).

It is possible to ask for express shipping or to split the shipping of an order. However, the price of shipping and handling will be applied to each delivery.

Any dispute or complaint relating to our deliveries must be submitted in writing within 15 days of the date of delivery.

6. Returns

All returns must be subject to an agreement with our services. In all cases, returns must be addressed to our factory, freight and taxes paid by the customer. Nonstandard and customized merchandise, merchandise that has been damaged or modified may not be returned. Standard merchandise that is in good condition may be returned within 12 months after shipment at the latest. A 30% decrease in the sales price will be applied.

7. Shipping & Delivery

Once it is shipped, the merchandise is the responsibility of the transport company. In the event of damaged or missing merchandise, it is advised to point it out in writing on the carrier receipt and to send a registered letter to the carrier within 48 hours of receipt of merchandise.

8. After-sales service

The transit of material carries a transfer of risks of loss or destruction of merchandise, subject to the damage that could occur. In this event, a quote is sent to the customer within 10 days. After accepting this quote by means of a purchase order, the products are returned within maximum 10 days. The cost of shipping remains the responsibility of the customer. If the customer does not respond within four weeks after the delivery of the estimate, the customer will be reminded per email. If there is no response within 3 months, the merchandise will be destroyed. In the case of a refusal, the merchandise will be returned at the customers expense.

9. Catalogue

Any images or drawings depicted in our catalogue or other documents are only meant to be a guide and are not eligible for dispute or complaint. We use the commonly accepted dimensions and specifications for our merchandise. We reserve the right to modify or change at any moment the merchandise shown in the catalogue or to stop the sale of these items, and this may not be held against us in any form.

POK, its name is a story...

In the nineteenth century, my great-grandfather founded the National Office of meteorology in France. His knowledge of the climate led him to choose Saint Cast in Brittany for his holidays. He built a family home beside a large sandy beach. For a young boy, this idyllic location offers only the beach and the sea to pass the time.

For my tenth birthday my father gave me a sailboat. You should know that in Saint Cast, two kinds of sailors face the sea, one of the roughest in the world, with swirling winds, a coastline indented with tidal elevations of 15 meters, and currents that reach 5 knots: fishermen and yachtsmen.

Fishermen painted the name on their boat, yachtsmen inscribed the name of their vessel in copper letters: very expensive for a little boy with no income. The Breton (a Celtic language related to Gaelic) dictionary provided me with a three letter name that was sound, vigorous and ready to brave the marine elements: POK.

My sailboat, the POK, sailed faithfully, never tipping or sinking. Therefore, when I created my company, naming it after my boat seemed a good choice for luck in the future.

POK!, I forgot to tell you, means "kiss" in Breton. A kiss that brings smiles, joy and confidence in those one meets.

Bruno GRANDPIERRE

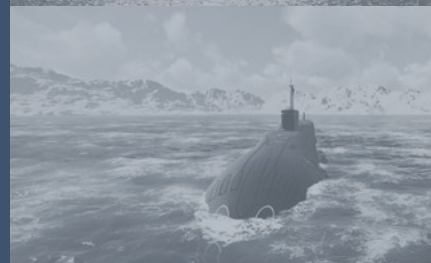
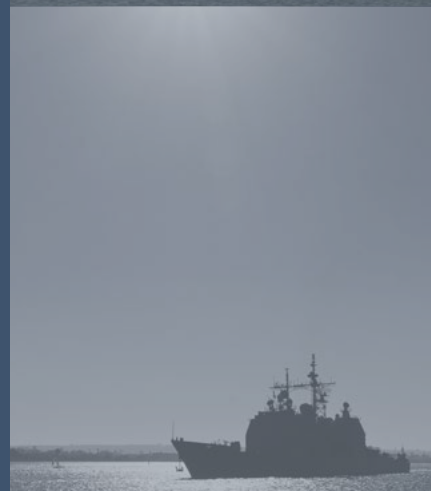

POK SAS - ZI les Guignons - 10400 Nogent-sur-Seine - FRANCE

Tel : +33 (0)3 25 39 84 78 - Fax : +33 (0)3 25 39 84 90 - Email : info@pok.fr - web : www.pok.fr

RCS : Troyes 90 B 279

Photographs, pictures and texts are not contractually binding.
The information presented in this catalogue is subject to change without notice.



POK SAS - ZI les Guignons - 10400 Nogent-sur-Seine - FRANCE
Tel : +33 (0)3 25 39 84 78 - Fax : +33 (0)3 25 39 84 90 - Email : info@pok.fr - web : www.pok.fr

